



SİPARİŞ KODU ORDER CODE Артикул	KOD CODE КОД	AÇIKLAMA DESCRIPTION / НАИМЕНОВАНИЕ	F			
101-99-73	ZETA02	Sürme Kapak Makarası <i>Sliding door roller</i> Ролик раздвижной двери <i>(Yavaşlatıcı) (With Soft Closing Damper) (С доводчиком)</i>	601	39 x 29 x 31	18,500 kg	12 Set компл.





AL220BT

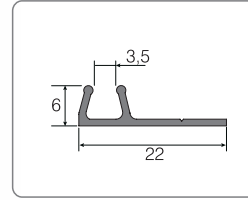
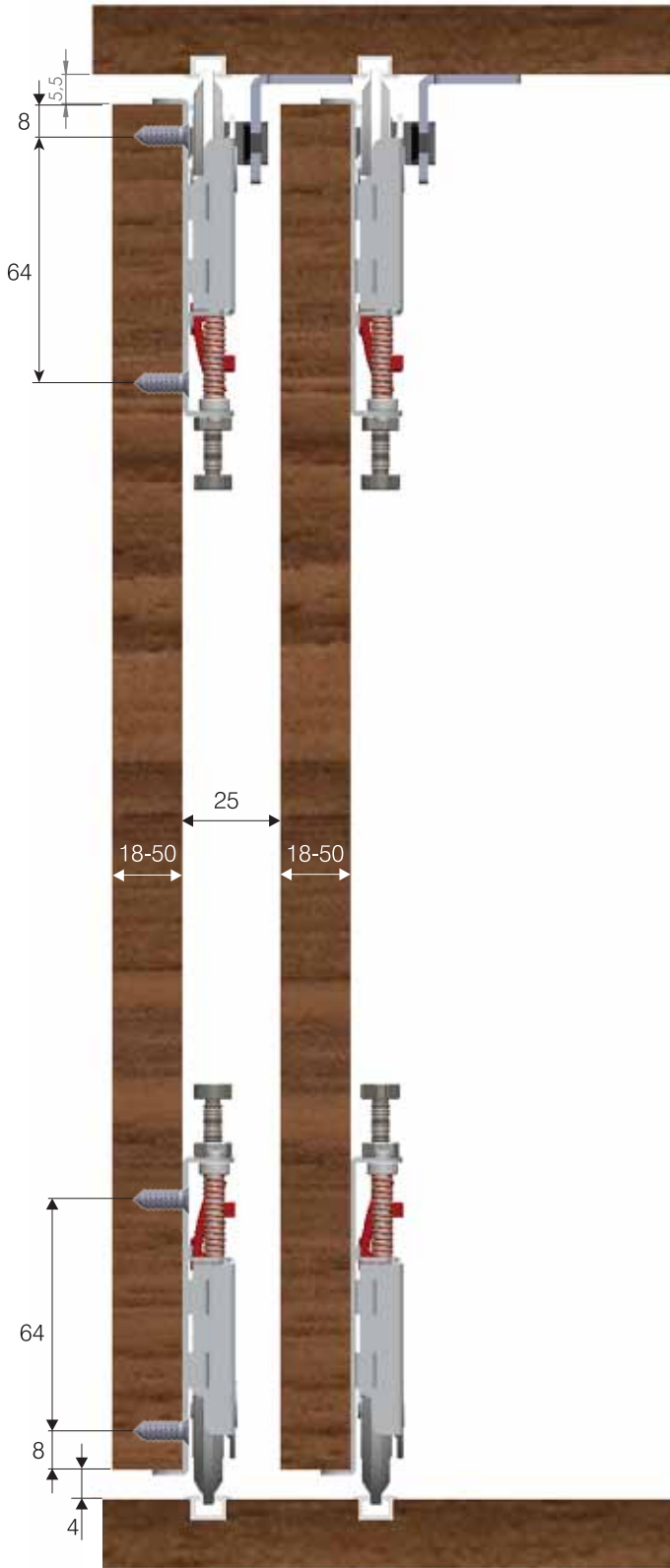
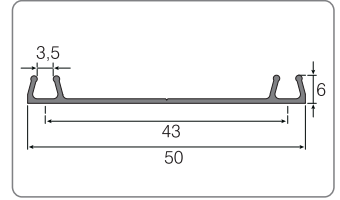

AL500BT

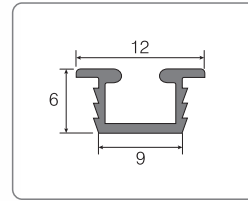

AL129BT

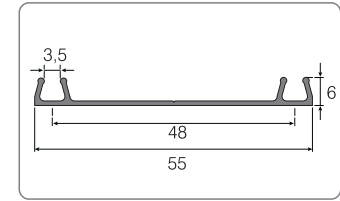

AL550BT

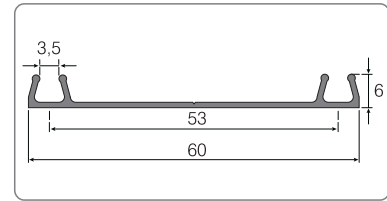

AL600BT

**ÜRÜN ÖZELLİKLER**  
**PRODUCT SPECIFICATIONS**  
**ОСНОВНЫЕ ХАРАКТЕРИСТИКИ ПРОДУКТА**

- 18mm 'den 50mm 'ye kadar farklı kapak kalınlıklarına göre ayarlanabilir.
- 80 Kg taşıma kapasitelidir.
- 2 ve 3 kaplı sistemlerde uygulanabilir.

- Available from 18mm up to 50mm for different door thickness.
- Carrying capacity is 80 kg
- Available for 2 and 3 door systems

- Возможность использования дверных панелей от 18 до 50 мм толщиной.
- Системы рассчитаны на двери весом до 80 кг.
- Возможность установления систем с использованием 2 и 3 дверей.

**ZETA02**

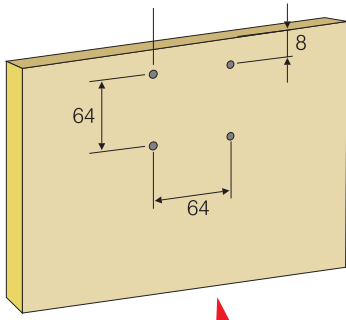

\* MS80 makaralarda hareketli makaranın kapalı pozisyonda kalmasını sağlayacak mandal sistemi vardır. Kapağın yerine konulmasından sonra mandalın üstüne basıldığı zaman makaranın ray üzerine girmesi sağlanır.

\* MS80 roller has lock pin to make moving roller as constant. After the door is assembled, MS80 roller is fitted inside the rail by pushing on the lock pin

\* В роликах MS80 имеется прижимная система для фиксации ролика в неподвижном состоянии. После размещения ролика на крышке и нажатии на фиксирующую защелку ролик будет зафиксирован на направляющей.

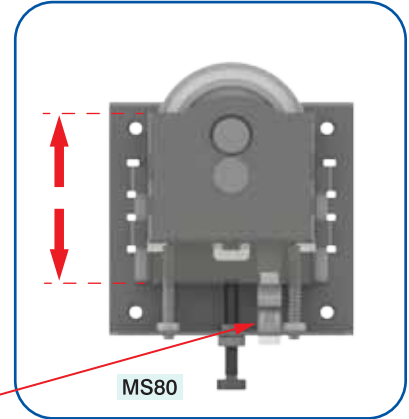

Tutucu mandal  
Lock pin  
фиксирующая защелка

